

新登場

エコ細目ステンレスグレーチング(ピッチ15mm) 歩道用

みぞぶた

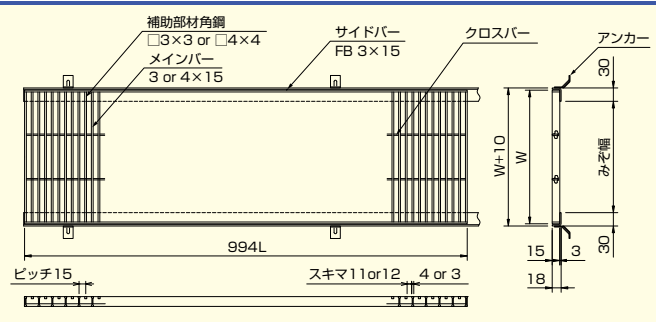
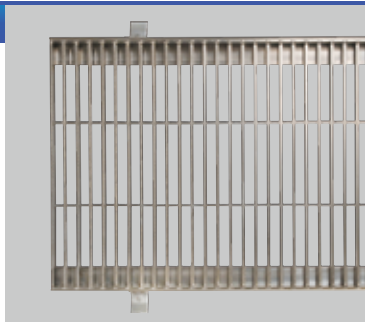
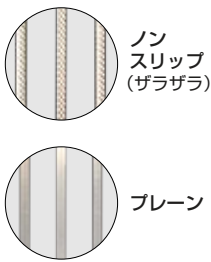

ダイクレ製品
のご紹介

型式別目次

テクニカル

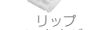
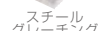
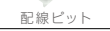
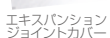
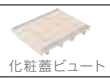

みぞ幅 (mm)	寸法		エコ細目グレーチング ピッチ15mm						受枠B枠	
			ブレーン			ノンスリップ(ザラザラ)			型式	1m両サイド 当り価格
			型式	重量(kg)	本体価格	型式	重量(kg)	本体価格		
100	994x150	15	ES3FMO15-1515	3.0	15,500	ES4IRO15-1515	3.9	17,500	B-15CH	6,600
150	994x200	15	ES3FMO20-1515	3.8	19,900	ES4IRO20-1515	4.9	22,600	B-15CH	6,600
200	994x250	15	ES3FMO25-1515	4.7	25,800	ES4IRO25-1515	6.1	29,200	B-15CH	6,600
250	994x300	15	ES3FMO30-1515	5.4	30,100	ES4IRO30-1515	7.2	33,700	B-15CH	6,600
300	994x350	15	ES3FMO35-1515	6.4	36,300	ES4IRO35-1515	8.4	40,200	B-15CH	6,600
350	994x400	15	ES3FMO40-1515	7.1	39,900	ES4IRO40-1515	9.4	44,700	B-15CH	6,600
400	994x450	15	ES3FMO45-1515	8.1	45,100	ES4IRO45-1515	10.7	49,300	B-15CH	6,600
450	994x500	15	ES3FMO50-1515	8.8	49,700	ES4IRO50-1515	11.7	56,500	B-15CH	6,600

ますぶた

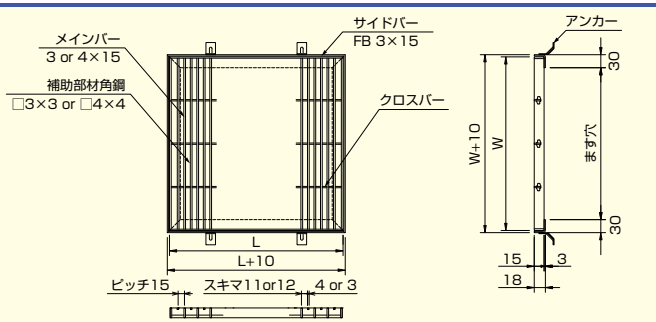
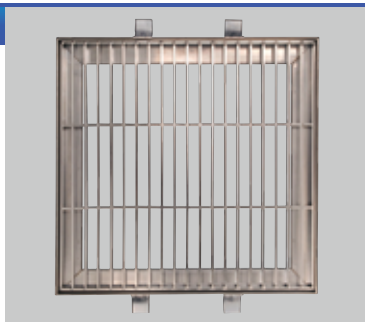
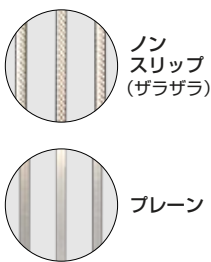

ます穴 (mm)	寸法		エコ細目グレーチング ピッチ15mm						受枠B枠	
			ブレーン			ノンスリップ(ザラザラ)			型式	受枠価格 (四周枠)
			型式	重量(kg)	本体価格	型式	重量(kg)	本体価格		
250x250	300x300	15	ES3FMD30-1515	1.7	9,100	ES4IRD30-1515	2.3	11,600	B-15WD	6,400
300x300	350x350	15	ES3FMD35-1515	2.4	12,700	ES4IRD35-1515	3.1	14,900	B-15WD	7,500
350x350	400x400	15	ES3FMD40-1515	3.0	16,300	ES4IRD40-1515	4.0	19,500	B-15WD	8,400
400x400	450x450	15	ES3FMD45-1515	3.8	20,500	ES4IRD45-1515	5.0	23,600	B-15WD	9,400
450x450	500x500	15	ES3FMD50-1515	4.6	24,500	ES4IRD50-1515	6.1	29,400	B-15WD	10,600

U字溝用

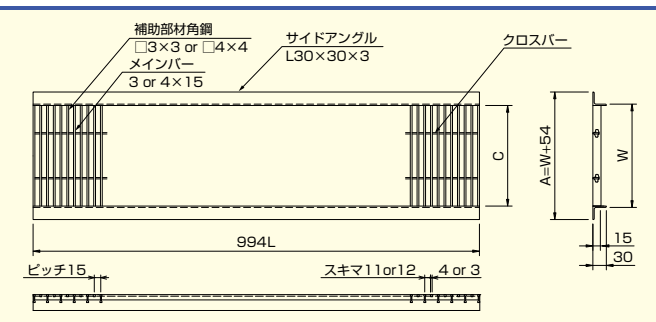
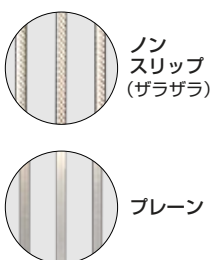

みぞ幅 (mm)	寸法					エコ細目グレーチング ピッチ15mm					
						ブレーン			ノンスリップ(ザラザラ)		
						型式	重量(kg)	本体価格	型式	重量(kg)	本体価格
90	994x74	80	134	15	ES3FMU90-1515	4.0	16,100	ES3FRU90-1515	4.0	17,400	
120	994x104	110	164	15	ES3FMU12-1515	4.5	19,600	ES4IRU12-1515	5.1	21,300	
150	994x134	140	194	15	ES3FMU15-1515	4.9	21,300	ES4IRU15-1515	5.7	22,700	
180	994x164	170	224	15	ES3FMU18-1515	5.3	23,900	ES4IRU18-1515	6.3	26,100	
240	994x224	230	284	15	ES3FMU24-1515	6.4	31,500	ES4IRU24-1515	7.8	32,500	
300	994x284	290	344	15	ES3FMU30-1515	7.3	35,200	ES4IRU30-1515	9.0	38,000	

*エコ細目ステンレスグレーチングは歩道用限定として使用して下さい。